

Absender / Firmenstempel | Sender / Company stamp  
Expéditeur / cachet de société | Mittente / Timbro della ditta:

Ansprechpartner | Contact | Responsable | Interlocutore:

--

Grosshandel | Wholesaler | Grossiste | Grossista:

--

Kommission | Commission | Commissione:

--

Auftrags Nr. | Order No. | Ordre No. | N°. d'ordine

--

Glas Nr. | Glass No. | Verre No. | Vetro N°:

--

Farbe Nr. | Colour No. | Couleur No. | Colore N°:

--

Handtuchhalter | Towel-Rack | Porte serviette | Portasciugamani:

Länge | Length | Longueur | Lungo

Einbauhöhe | Fixing height | Hauteur de fixation |

Altezza di fissaggio:  mm

Traverse | Stabilising bar | Traverse | Traversa

Nein | No | Non | No  Ja | Yes | Oui | Si

Bereits montiert | already fitted | déjà fixé | già montato

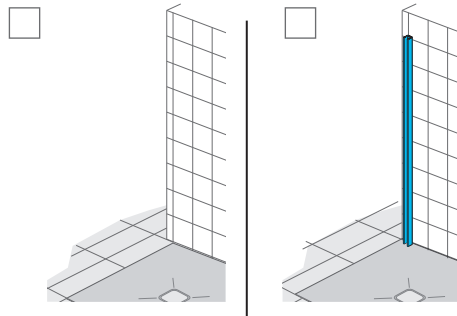

Bitte um Kostenvoranschlag gemäss Angaben  
Send me an offer according the specifications  
Demande d'offre selon données ci-dessus  
Di farmi un preventivo-rispetto a questo box doccia

Diese Vorlage gilt bereits als Auftrag  
Ordering according the mentioned specifications  
Commande selon données ci-dessus  
Questo progetto e valido come ordine

Datum | Date | Date | Data:

Unterschrift | Signature | Signature | Firma

Masse (in mm) hier eintragen  
Here to put down measures (in mm)  
Indiquez ici les mesures (en mm)  
Inserire le misure (in mm)

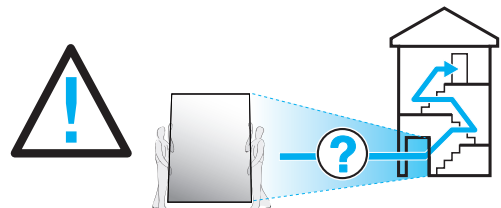
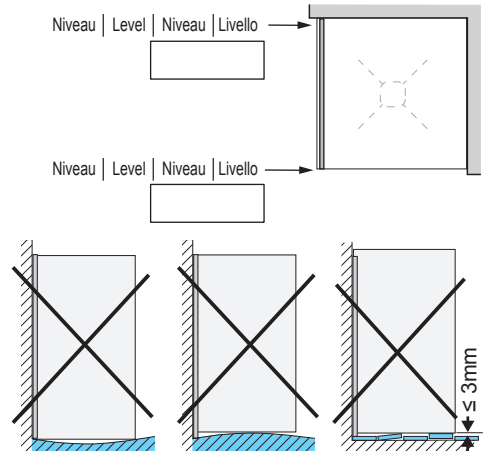
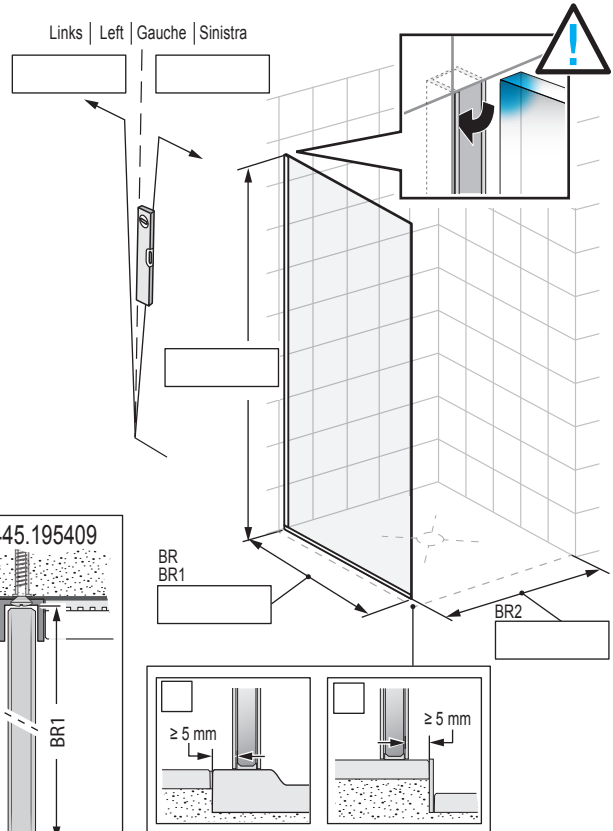
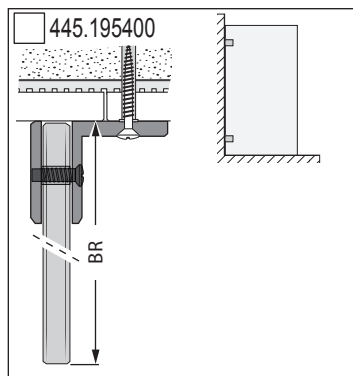
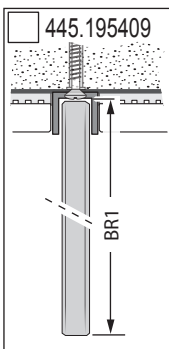
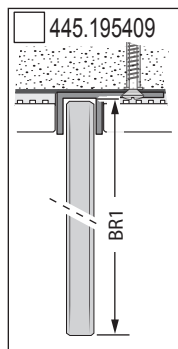
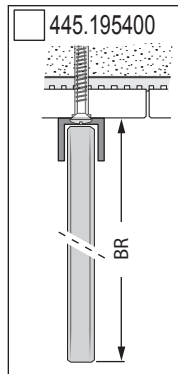

Platz für weitere Informationen  
Place for further information  
Place pour informations supplémentaires  
Spazio per altre informazioni