

AIR 342.195400  
 FJORD AIR 342.195405

DLIGHT AIR 342.195401 / 342.195411  
 DLIGHT FJORD AIR 342.195406



Absender / Firmenstempel | Sender / Company stamp  
 Expéditeur / cachet de société | Mittente / Timbro della ditta:

\_\_\_\_\_  
 \_\_\_\_\_  
 \_\_\_\_\_  
 \_\_\_\_\_

Ansprechpartner | Contact | Responsable | Interlocutore:

\_\_\_\_\_

Grosshandel | Wholesaler | Grossiste | Grossista:

\_\_\_\_\_

Kommission | Commission | Commissione:

\_\_\_\_\_

Auftrags Nr. | Order No. | Ordre No. | N° d'ordine

\_\_\_\_\_

Rapport Nr. | Report No. | Rapport No. | Rapporto N°

\_\_\_\_\_

Glas Nr. | Glass No. | Verre No. | Vetro N°:

\_\_\_\_\_

Farbe Nr. | Colour No. | Couleur No. | Colore N°: **214**

Handtuchhalter | Towel-Rack | Porte serviette | Portasciugamani:

Länge | Length | Longueur | Lungo \_\_\_\_\_ mm

Einbauhöhe | Fixing height | Hauteur de fixation |

Altezza di fissaggio: \_\_\_\_\_ mm

Bereits montiert | already fitted | déjà fixé | già montato

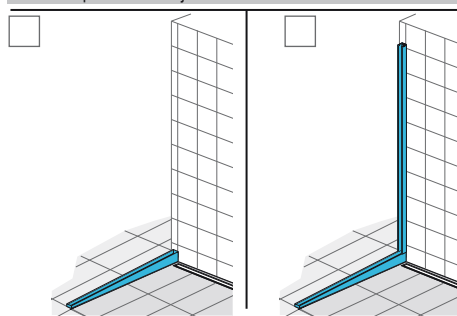
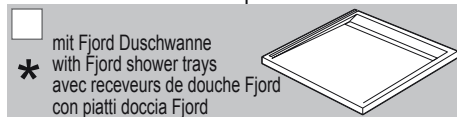
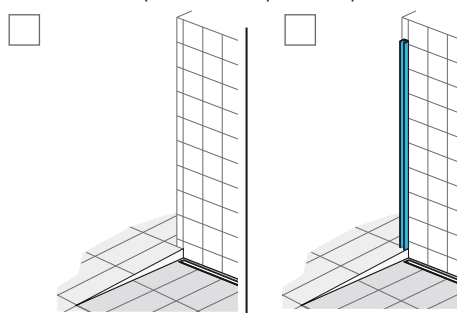

Bitte um Kostenvoranschlag gemäss Angaben  
 Send me an offer according the specifications  
 Demande d'offre selon données ci-dessus  
 Di farmi un preventivo-rispetto a questo box doccia

Diese Vorlage gilt bereits als Auftrag  
 Ordering according the mentioned specifications  
 Commande selon données ci-dessus  
 Questo progetto e valido come ordine

Datum | Date | Date | Data: \_\_\_\_\_

Unterschrift | Signature | Signature | Firma

Masse (in mm) hier eintragen  
 Here to put down measures (in mm)  
 Indiquez ici les mesures (en mm)  
 Inserire le misure (in mm)

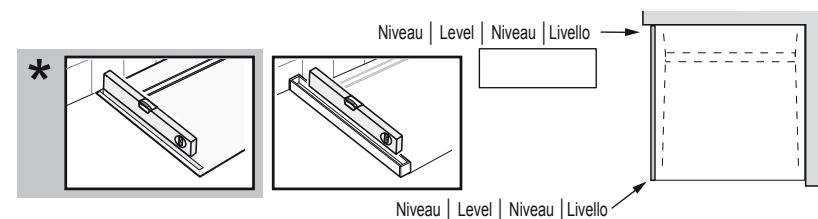
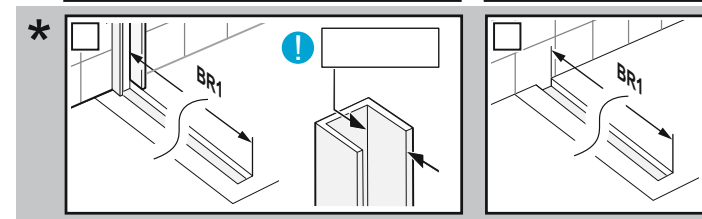
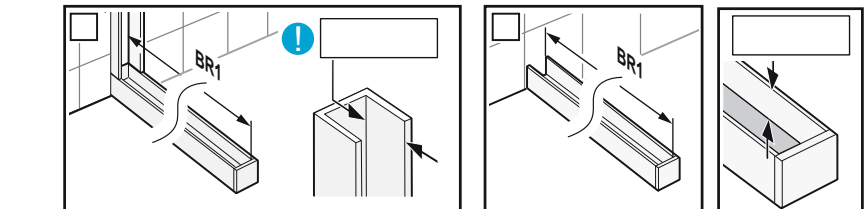
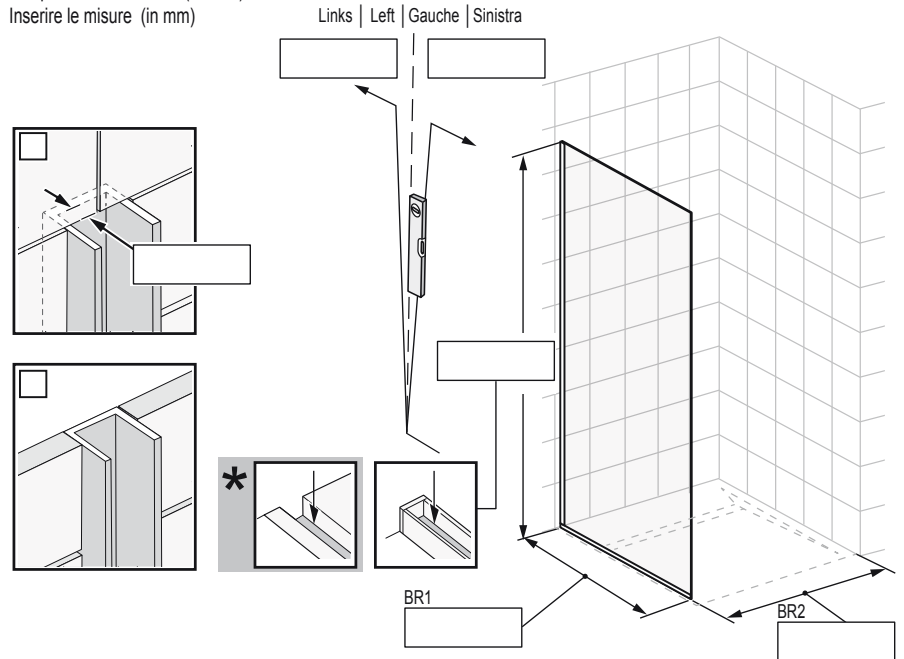

! **Min. 28 mm** für | for | pour | per:  
 DLIGHT AIR 342.195401  
 DLIGHT FJORD AIR 342.195406  
 DLIGHT AIR UP 342.195411

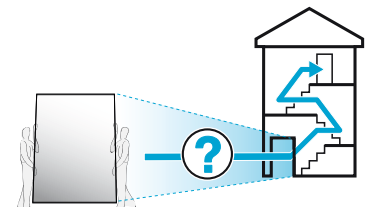

Platz für weitere Informationen  
 Place for further information  
 Place pour informations supplémentaires  
 Spazio per altre informazioni

AIR 342.205400  
 FJORD AIR 342.205405

DLight AIR 342.205401 / 342.205411  
 DLight FJORD AIR 342.205406



Absender / Firmenstempel | Sender / Company stamp  
 Expéditeur / cachet de société | Mittente / Timbro della ditta:

\_\_\_\_\_  
 \_\_\_\_\_  
 \_\_\_\_\_  
 \_\_\_\_\_

Ansprechpartner | Contact | Responsable | Interlocutore:

\_\_\_\_\_

Grosshandel | Wholesaler | Grossiste | Grossista:

\_\_\_\_\_

Kommission | Commission | Commissione:

\_\_\_\_\_

Auftrags Nr. | Order No. | Ordre No. | N° d'ordine

\_\_\_\_\_

Rapport Nr. | Report No. | Rapport No. | Rapporto N°

\_\_\_\_\_

Glas Nr. | Glass No. | Verre No. | Vetro N°:

\_\_\_\_\_

Farbe Nr. | Colour No. | Couleur No. | Colore N°: 214

Handtuchhalter | Towel-Rack | Porte serviette | Portasciugamani:

Länge | Length | Longueur | Lungo \_\_\_\_\_ mm

Einbauhöhe | Fixing height | Hauteur de fixation |

Altezza di fissaggio: \_\_\_\_\_ mm

Bereits montiert | already fitted | déjà fixé | già montato

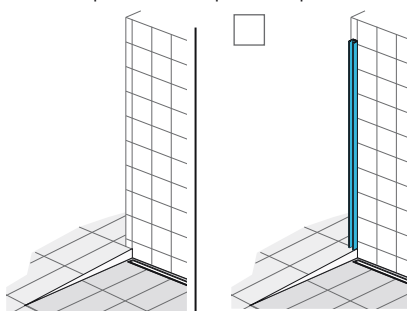

mit Fjord Duschwanne  
 \* with Fjord shower trays  
 avec receveurs de douche Fjord  
 con piatti doccia Fjord

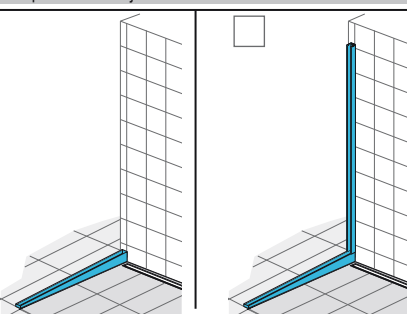
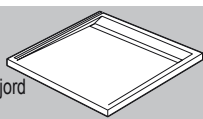

Bitte um Kostenvoranschlag gemäss Angaben  
 Send me an offer according the specifications  
 Demande d'offre selon données ci-dessus  
 Di farmi un preventivo-rispetto a questo box doccia

Diese Vorlage gilt bereits als Auftrag  
 Ordering according the mentioned specifications  
 Commande selon données ci-dessus  
 Questo progetto e valido come ordine

Datum | Date | Date | Data: \_\_\_\_\_

Unterschrift | Signature | Signature | Firma

Masse (in mm) hier eintragen  
 Here to put down measures (in mm)  
 Indiquez ici les mesures (en mm)  
 Inserire le misura (in mm)

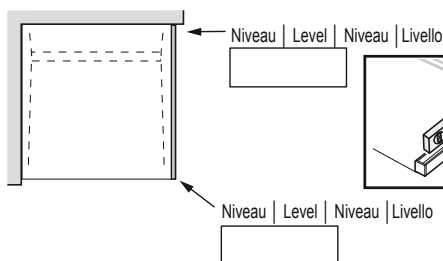
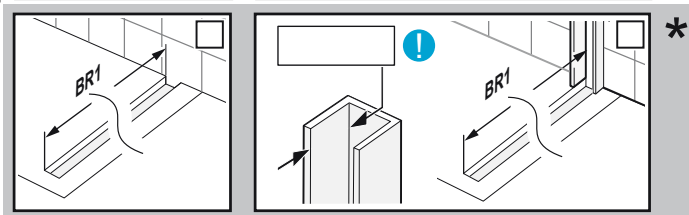
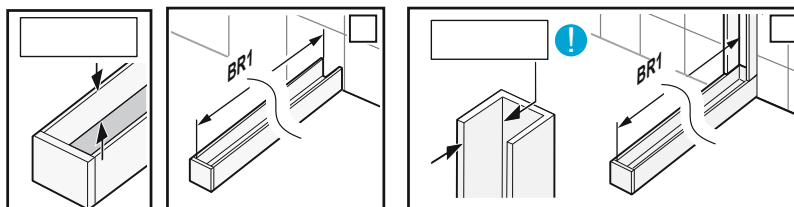
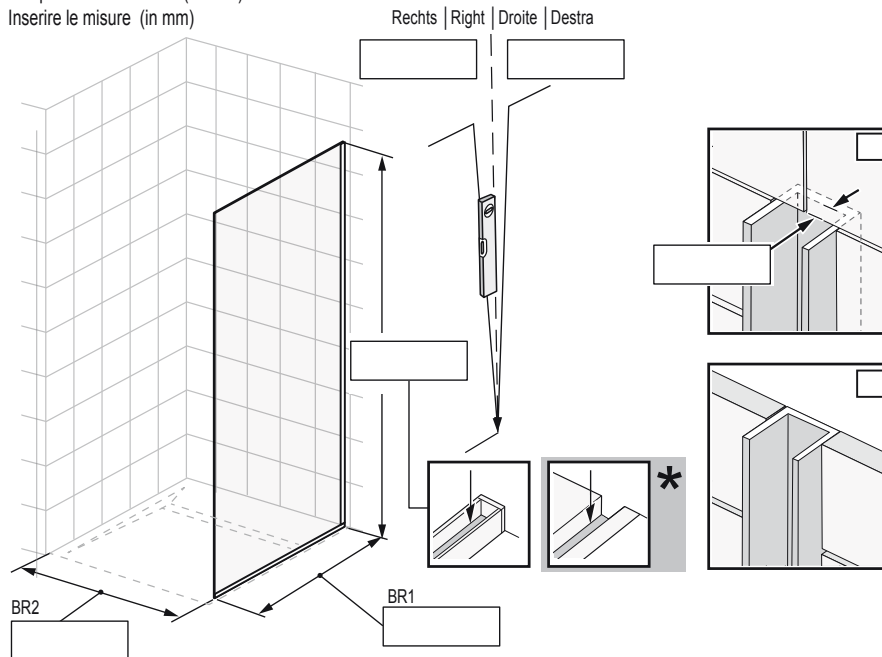

**!** Min. 28 mm für | for | pour | per:  
 DLight AIR 342.205401  
 DLight FJORD AIR 342.205406  
 DLight AIR UP 342.205411

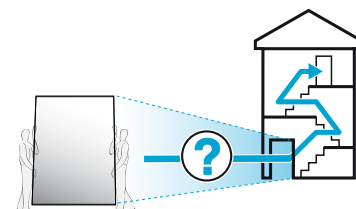

Platz für weitere Informationen  
 Place for further information  
 Place pour informations supplémentaires  
 Spazio per altre informazioni

Absender / Firmenstempel | Sender / Company stamp  
 Expéditeur / cachet de société | Mittente / Timbro della ditta:

Ansprechpartner | Contact | Responsable | Interlocutore:

--

Grosshandel | Wholesaler | Grossiste | Grossista:

--

Kommission | Commission | Commissione | Commissione:

--

Auftrags Nr. | Order No. | Ordre No. | N° d'ordine

--

Rapport Nr. | Report No. | Rapport No. | Rapporto N°

--

Glas Nr. | Glass No. | Verre No. | Vetro N°:

--

Farbe Nr. | Colour No. | Couleur No. | Colore N°: **214**

Handtuchhalter | Towel-Rack | Porte serviette | Portasciugamani:

Länge | Length | Longueur | Lungo  mm

Einbauhöhe | Fixing height | Hauteur de fixation |

Altezza di fissaggio:  mm

Bereits montiert | already fitted | déjà fixé | già montato

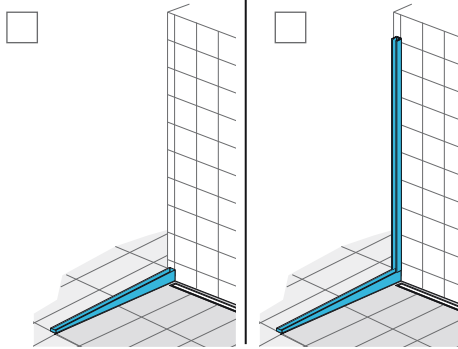
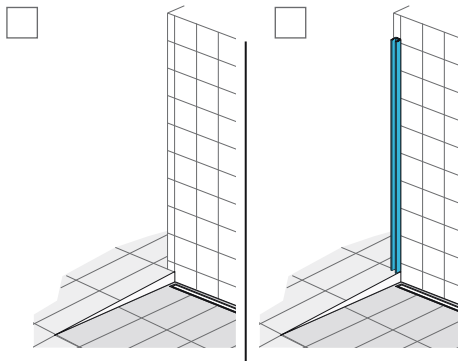

Bitte um Kostenvoranschlag gemäss Angaben  
 Send me an offer according the specifications  
 Demande d'offre selon données ci-dessus  
 Di farmi un preventivo-rispetto a questo box doccia

Diese Vorlage gilt bereits als Auftrag  
 Ordering according the mentioned specifications  
 Commande selon données ci-dessus  
 Questo progetto e valido come ordine

Datum | Date | Date | Data:

Unterschrift | Signature | Signature | Firma

Masse (in mm) hier eintragen  
 Here to put down measures (in mm)  
 Indiquez ici les mesures (en mm)  
 Inserire le misure (in mm)

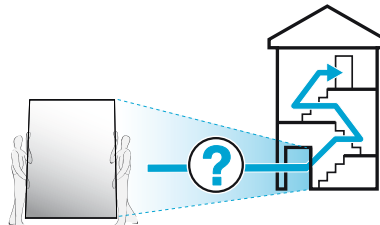
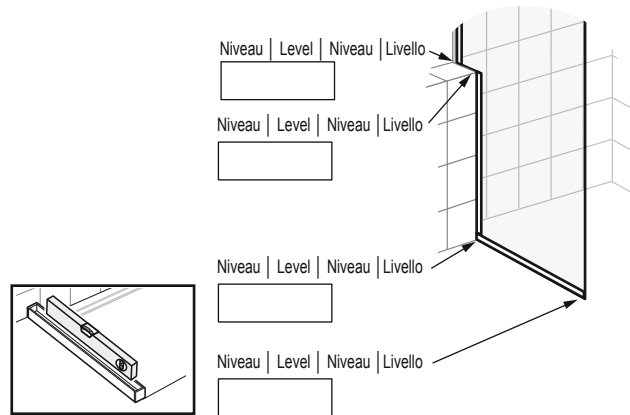
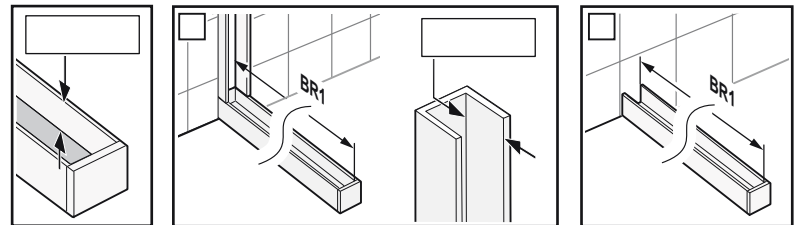
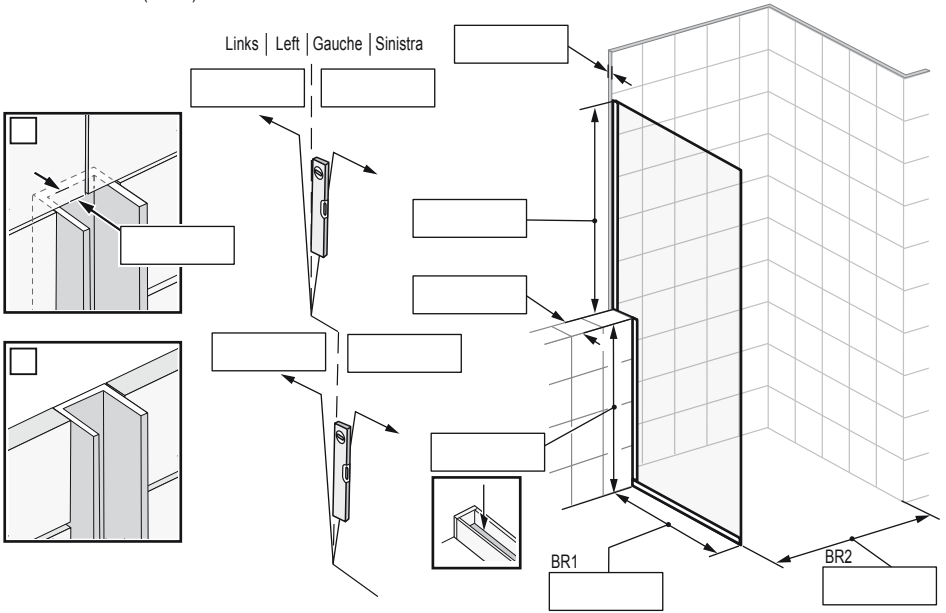

Platz für weitere Informationen  
 Place for further information  
 Place pour informations supplémentaires  
 Spazio per altre informazioni

Absender / Firmenstempel | Sender / Company stamp  
 Expéditeur / cachet de société | Mittente / Timbro della ditta:

Ansprechpartner | Contact | Responsable | Interlocutore:

--

Grosshandel | Wholesaler | Grossiste | Grossista:

--

Kommission | Commission | Commissione | Commissione:

--

Auftrags Nr. | Order No. | Ordre No. | N°. d'ordine

--

Rapport Nr. | Report No. | Rapport No. | Rapporto N°

--

Glas Nr. | Glass No. | Verre No. | Vetro N°:

--

Farbe Nr. | Colour No. | Couleur No. | Colore N°: **214**

Handtuchhalter | Towel-Rack | Porte serviette | Portasciugamani:

Länge | Length | Longueur | Lungo  mm

Einbauhöhe | Fixing height | Hauteur de fixation |

Altezza di fissaggio:  mm

Bereits montiert | already fitted | déjà fixé | già montato

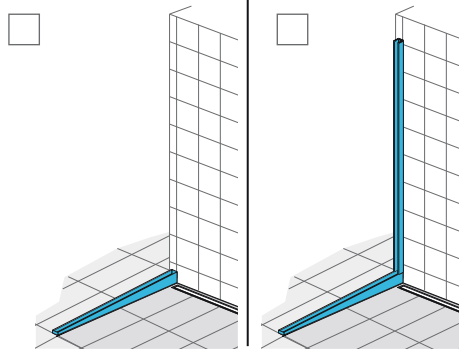
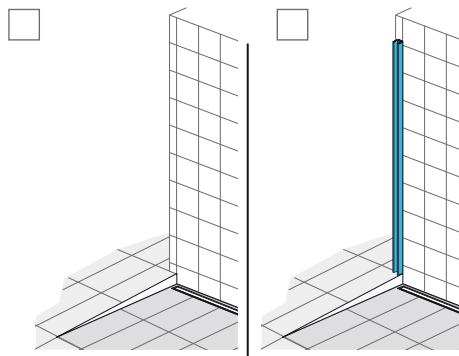

Bitte um Kostenvoranschlag gemäss Angaben  
 Send me an offer according the specifications  
 Demande d'offre selon données ci-dessus  
 Di farmi un preventivo-rispetto a questo box doccia

Diese Vorlage gilt bereits als Auftrag  
 Ordering according the mentioned specifications  
 Commande selon données ci-dessus  
 Questo progetto e valido come ordine

Datum | Date | Date | Data:

Unterschrift | Signature | Signature | Firma

Masse (in mm) hier eintragen  
 Here to put down measures (in mm)  
 Indiquez ici les mesures (en mm)  
 Inserire le misure (in mm)

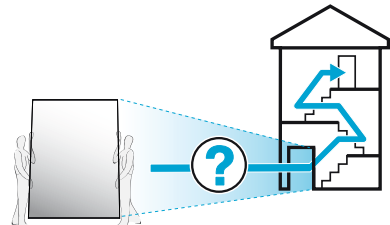
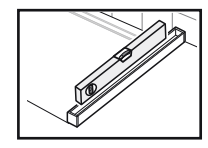
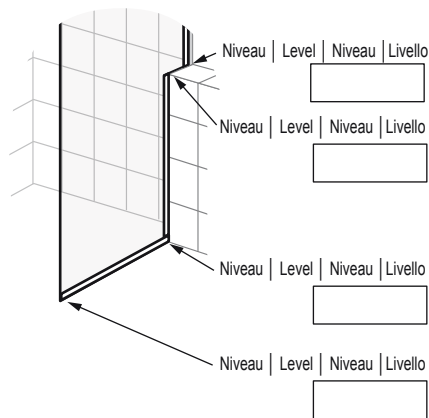
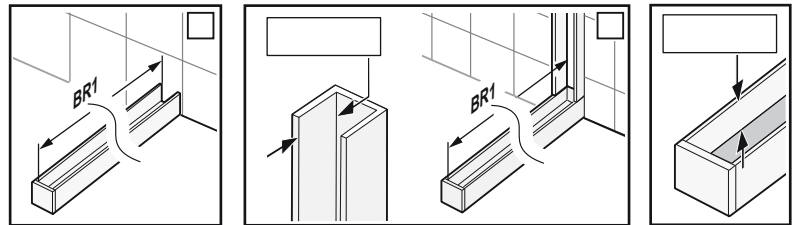
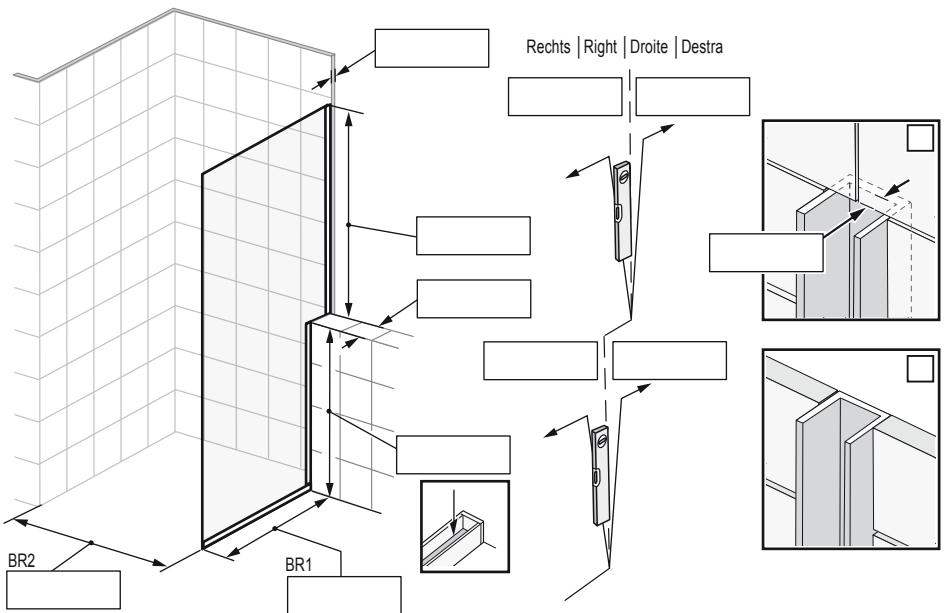

Platz für weitere Informationen  
 Place for further information  
 Place pour informations supplémentaires  
 Spazio per altre informazioni

Absender / Firmenstempel | Sender / Company stamp  
 Expéditeur / cachet de société | Mittente / Timbro della ditta:

Ansprechpartner | Contact | Responsable | Interlocutore:

--

Grosshandel | Wholesaler | Grossiste | Grossista:

--

Kommission | Commission | Commissione:

--

Auftrags Nr. | Order No. | Ordre No. | N° d'ordine

--

Rapport Nr. | Report No. | Rapport No. | Rapporto N°

--

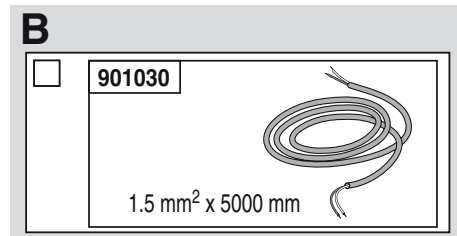
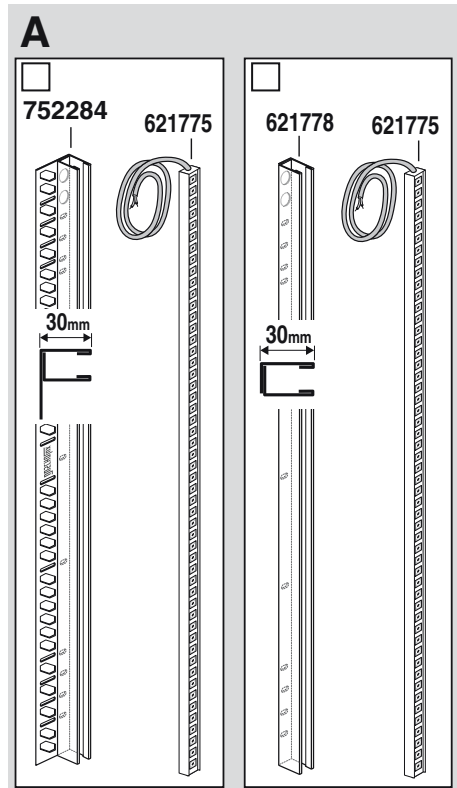

Bitte um Kostenvoranschlag gemäss Angaben  
 Send me an offer according the specifications  
 Demande d'offre selon données ci-dessus  
 Di farmi un preventivo-rispetto a questo box doccia

Diese Vorlage gilt bereits als Auftrag  
 Ordering according the mentioned specifications  
 Commande selon données ci-dessus  
 Questo progetto e valido come ordine

Datum | Date | Date | Data:

Unterschrift | Signature | Signature | Firma

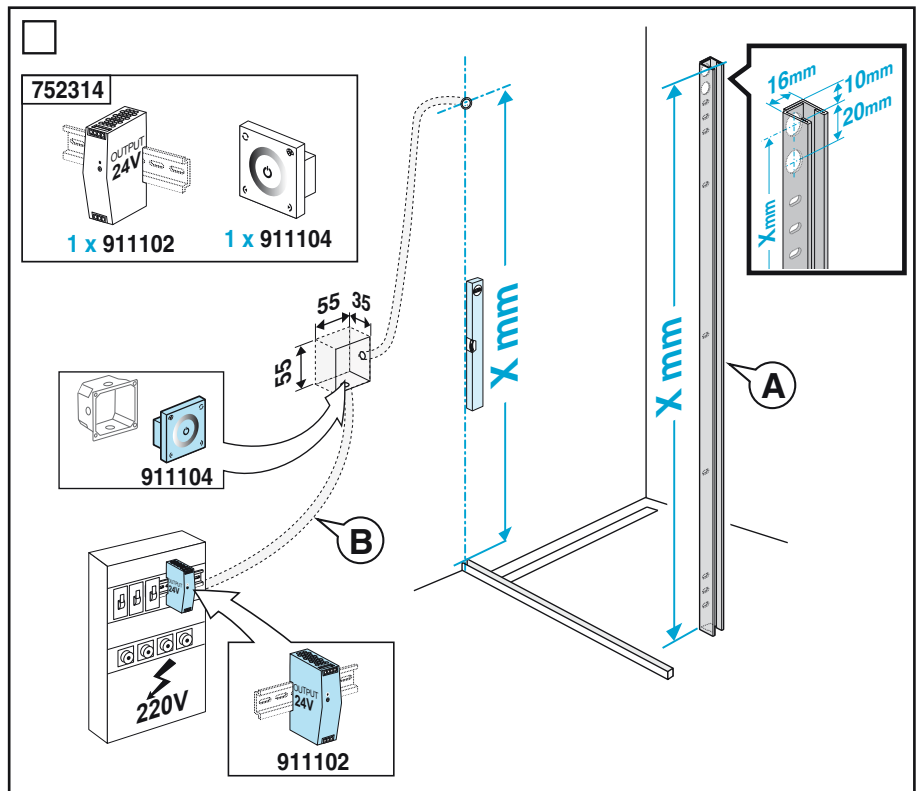
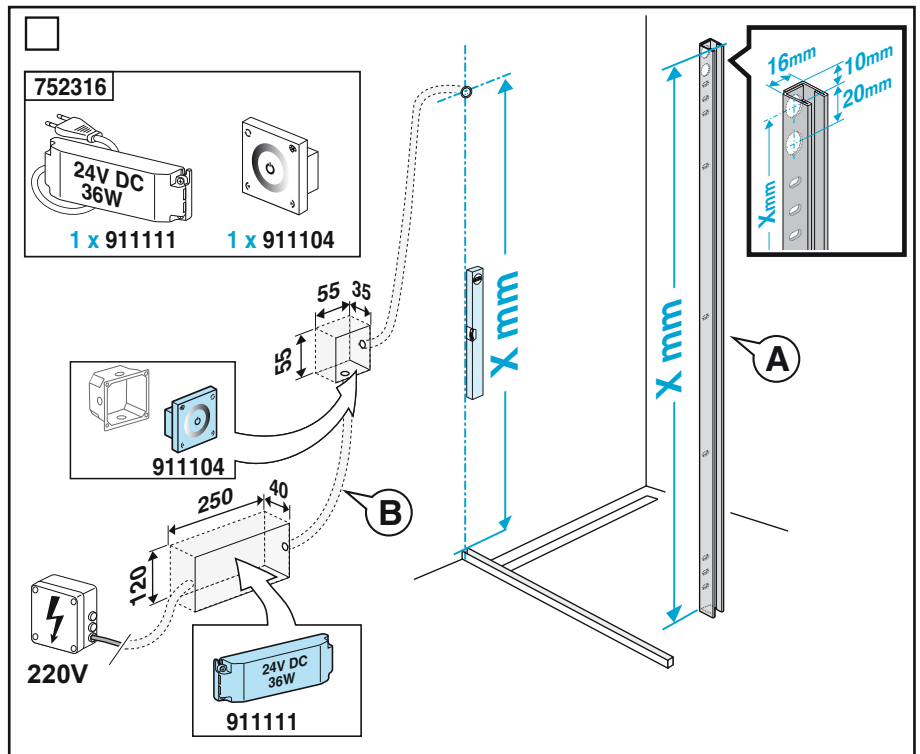
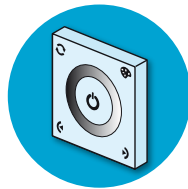

Absender / Firmenstempel | Sender / Company stamp  
Expéditeur / cachet de société | Mittente / Timbro della ditta:

Ansprechpartner | Contact | Responsable | Interlocutore:

--

Grosshandel | Wholesaler | Grossiste | Grossista:

--

Kommission | Commission | Commissione:

--

Auftrags Nr. | Order No. | Ordre No. | N°. d'ordine

--

Rapport Nr. | Report No. | Rapport No. | Rapporto N°

--

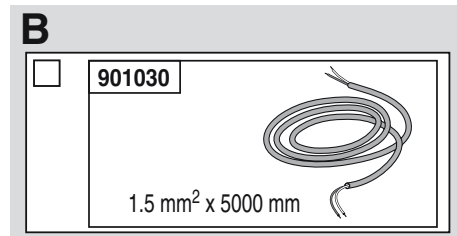
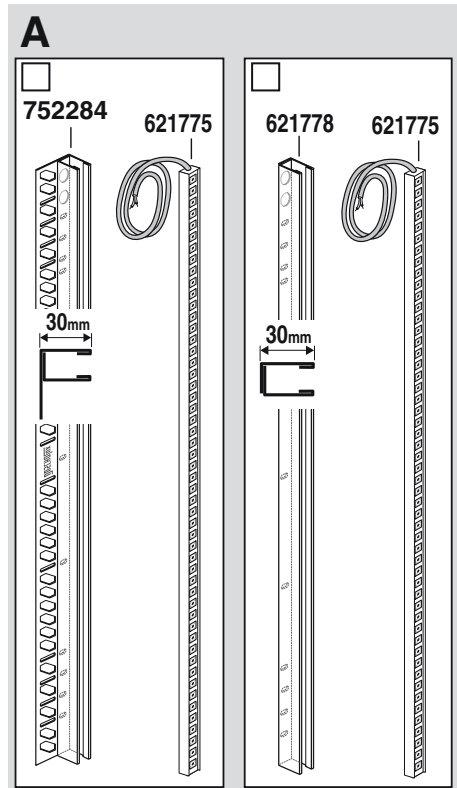

Bitte um Kostenvoranschlag gemäss Angaben  
Send me an offer according the specifications  
Demande d'offre selon données ci-dessus  
Di farmi un preventivo-rispetto a questo box doccia

Diese Vorlage gilt bereits als Auftrag  
Ordering according the mentioned specifications  
Commande selon données ci-dessus  
Questo progetto e valido come ordine

Datum | Date | Date | Data:

Unterschrift | Signature | Signature | Firma

